

A simulation model of the locomotion controllers for the nematode *Caenorhabditis elegans*

John Bryden and Netta Cohen*

School of Computing
Leeds University
Leeds LS2 9JT
United Kingdom

Abstract

This paper presents a simple yet biologically-grounded model of the *C. elegans* neural circuit for forward locomotive control. The model considers a limited subset of the *C. elegans* nervous system, within a minimal two-dimensional environment. Despite its reductionist approach, this model is sufficiently rich to generate patterns of undulations that are reminiscent of the biological worm's behaviour and qualitatively similar to patterns which have been shown to generate locomotion in a model of a richer physical environment. Interestingly, and contrary to conventional wisdom about neural circuits for motor control, our results are consistent with the conjecture that the worm may be relying on feedback from the shape of its body to generate undulations that propel it forward or backward.

1. Introduction

There is an increasing body of work on the evolution of artificial neural circuits for motor control. These artificial circuits commonly share, or are inspired by, morphological and physiological features of biological model systems and are designed to mimic biological behaviour and functionality. Much of the work has been inspired by relatively complex motor control systems of vertebrates such as swimming in the lamprey (Ijspeert et al., 1999) and walking/swimming in the salamander (Ijspeert, 2001). Given partial information about the circuitry and by invoking a meaningful fitness function, artificial neural circuitry is evolved and its performance tested within the framework of a simulation model. The present work follows similar principles but is inspired by a much simpler, invertebrate nervous system, that of the nematode *C. elegans*.

The *C. elegans* nervous system's simplicity lends itself well to this approach. With one of the simplest

known nervous systems, it has been called 'the hydrogen atom of systems neuroscience' (Ferrée, 2003). Its 302 neurons (White et al., 1986) represent a mere drop in the ocean as compared with the human's one hundred billion neurons. Considering its modest size, the nervous system is capable of rather sophisticated functions including traversing chemical and temperature gradients and even memory (Rose and Rankin, 2001).

One feature that makes the *C. elegans* nervous system an excellent candidate for study is the fact that, as an invertebrate, it is hard wired: Every individual has the same neural circuitry. In 1986, an extremely comprehensive map of the *C. elegans* nervous system was produced by White et al. (White et al., 1986). Every neuron and many of the connections have been identified. This, supplemented by the mapping of the *C. elegans* genome (The *C. elegans* Sequencing Consortium, 1998), provide a wealth of information, deeming *C. elegans* a modeller's paradise. While modelling an entire iguana (in the spirit of Daniel Dennett's 1978 call) may still be a daunting challenge for simulation modellers, a complete model of the *C. elegans* nervous system is slowly taking shape.

The worm's behaviour can be broken down into various components – forward and backward motion, turning, chemotaxis, thermotaxis – each of which can be studied independently due to the corresponding modularity of the nervous system. Previous work modelling the *C. elegans* nervous system has been done on chemotaxis (Ferrée and Lockery, 1999), the tap withdrawal reflex (Wicks et al., 1996) and locomotion control (Niebur and Erdős, 1993).

The modularity of the *C. elegans* nervous system is both structural and functional. One subsystem that stands out is the locomotion system, containing roughly 63 neurons and only sparsely connected to the rest of the nervous system. Within the locomotion nervous system, sub-modules can easily be identified. In particular, it appears that, to a good first approximation, the forward locomotion subsystem can be isolated from backward locomotion and turning, thus providing us with a relatively compact and well defined task. However, before delving

*Corresponding author: netta@comp.leeds.ac.uk

into the model itself, some additional background is provided about the *C. elegans* nervous system which led us to important assumptions in our model.

C. elegans is a small worm, generally growing to only 1mm in length (Wood, 1988). This simple organism, 959 cells in total (Wood, 1988), nonetheless has many of the features found in much larger and more complex organisms.

To move, *C. elegans* must lie on its side with contractions alternating dorso-ventrally (from top to bottom). Undulations propagate along the worm in the opposite direction to movement, propelling it forward or backward. Longitudinal muscles pull on the skin, an impermeable and elastic sealed high-pressure tube, to generate these undulations. Nerve processes that run along the body innervate the muscles. The worm also uses touch sensors in the head and tail to enable it to turn and reverse direction when it reaches an obstacle (Chalfie and White, 1988).

Like the locomotion of nematodes, the overwhelming majority of known motor activity in animals relies on the rhythmic contraction of muscles, which are controlled or regulated by neural networks. This rhythmic activity often consists of pairs of opposing muscles alternately contracting out of phase with each other. The same principle holds in *C. elegans*. In general, two different classes of mechanisms have been proposed to underlie such motor behaviour. One possibility is reflexes: the contraction of one muscle feeds back through the neural network to the opposing muscle, and vice versa. The second is that the neural network itself generates an endogenous rhythmic pattern to activate the muscles [see (Marder and Calabrese, 1996) for examples]. While historically surprising, such so-called *central pattern generating* (CPG) neural networks have been found throughout the animal kingdom and are generally believed to participate in almost all forms of motor behaviour.

Surprisingly, there is no known evidence of CPG circuits in *C. elegans*. For instance, many CPG circuits are dominated by inhibitory synapses. In contrast, an analysis of White's map of the *C. elegans* nervous system (White et al., 1986) established that the locomotion subsystem contains relatively sparse chemical synapses and, instead, abundant electrical (so-called *gap junction*) connections between neurons. These strong and fast bi-directional electrical connections typically serve to synchronise neurons. In a network with little inhibition and with abundant gap junctions, feedback-related mechanisms are more likely to underlie oscillations than centrally generated patterns.

An additional exciting difference between the *C. elegans* nervous system and most other nervous systems is the fact that its underlying neuronal mechanism is believed to use graded (otherwise known as electrotonic) potentials (Goodman et al., 1998). In contrast, most

known neurons in the animal kingdom generate fast, high-amplitude electrical spikes called action potentials. These pulses have similar pulse-forms and are therefore referred to as all-or-none signals, to imply that they can be regarded as binary signals. In contrast, neurons with graded-potential states form analogue motor control circuits.

In this work we have generated a biologically-inspired toy model of the neural control of *C. elegans* forward locomotion that exhibits qualitatively similar behaviour to that shown by the biological system. Rather than using the standard model of a chain of central pattern generators, our model relies on feedback from the shape of the worm's body to the neurons to generate undulations that propagate along the body. The model considers a subset of the *C. elegans* nervous system, within a reduced environment. The model neurons have analogue states and the circuitry contains no synapses. These premises constitute a novel and completely unprecedented approach to modelling of motor control circuits.

This work makes some progress toward bridging the gap between our knowledge of the *C. elegans* neural circuitry and our models of its motor behaviour. Neural circuitry provides little insight on neural activity and even less on the resulting motor activity. Conversely, stand-alone models of motor behaviour that do not derive from the neural circuitry may or may not be consistent with it. Here, we build on our knowledge of the neural circuitry and neuronal properties, on the one hand, and on simulation models of the resulting motor patterns, on the other, to obtain results that are consistent with both. The model obtained and computer simulations thereof have led to specific testable predictions about the neural circuitry and its role in the control of forward locomotion in the worm.

The model of the neural circuit presented in this work relies to a large extent on a mechanical model for the locomotion of the worm by Ernst Niebur and Paul Erdős (Niebur and Erdős, 1991). However, Niebur and Erdős focused on mechanical aspects of an embodied worm, including detailed interactions with the physical environment. In contrast, the present work focuses on the neural circuitry and its ability to support robust motor control, while the physical model is kept to a bare minimum. This approach leads to a simple, almost toy model of the forward locomotion control. The model will allow us to investigate the minimal requirements for producing the desired control patterns.

A process of stages was used to generate our final circuit, each stage generating a model which was optimised according to a fitness function. In analogy with Ijspeert's lamprey work (Ijspeert et al., 1999), the worm was broken up into segments (despite the fact that worm has no vertebrae). Thus, in the first stage, an oscillatory neural circuit was obtained for modelling the local bending of a

single segment. The second stage generated two coupled segments that would oscillate at a phase lag with feedback from the local bending. Finally eleven segments were linked together to complete the model of forward locomotion. The resulting model confirmed the feasibility of locomotion control with mechano-feedback.

The following section provides biological background on the nematode’s nervous system and presents a simplified model of the locomotion based largely on the recent mechanical model of locomotion in *C. elegans* (Niebur and Erdös, 1991). A methodology section provides the equations used to model the neurons, their inputs from the shape of the body and their outputs to the muscles. A detailed description of the simplified circuitry for a single segment, a pair of segments and a complete (11-segment) model is provided. The results are ordered according to these stages and comprise a single solution of the problem and its analysis. The paper closes with a discussion of the work and its results.

2. Biological background

This section considers more detail on the models of *C. elegans* neurons, locomotion circuitry and a relevant existing model of locomotion in the nematode.

2.1 *C. elegans* neurons

Like many invertebrate neurons, *C. elegans* neurons do not have complicated structures. Most have only one axon and no dendrites. Furthermore, as mentioned above, it is unlikely that *C. elegans* neurons fire action potentials. In particular, research done on an individual, identified, *C. elegans* neuron (Goodman et al., 1998) found that it did not fire Na^+ action potentials and that it was unlikely that it fired Ca^{2+} action potentials. Similar experiments (Goodman et al., 1998) done on 40 other, unidentified neurons also showed similar results.

2.2 Forward locomotion

A mechanical model of the body of *C. elegans* was produced by Ernst Niebur and Paul Erdös (Niebur and Erdös, 1991). Their model worm was divided into segments, with each segment incorporating details of interior fluid pressure, elastic forces generated by the cuticle, muscular forces and external forces arising from movement within a groove of agar. Using computer simulations of the muscle excitation patterns, Niebur and Erdös demonstrated how locomotion could be generated in their model environment.

In a related publication (Niebur and Erdös, 1993), a number of different candidates for muscle excitation patterns were presented. One pattern which was sub-optimal but still capable of propelling the worm, stood out due to its simplicity and similarity with a model for

the locomotion of snakes identified by Gray (Gray, 1950, Gray, 1953). This pattern (which they dubbed the *stretch receptor pattern*) generated contractions only in muscles located on the outer curve of the ‘S’ shape of the *C. elegans* body, toward the direction of the locomotion (see Figure 1). Niebur and Erdös demonstrated that the muscle excitation patterns in their model could in principle be generated even with very primitive models of motoneurons (Niebur and Erdös, 1991). Such minimal motoneurons would act as thresholding units and would require feedback from stretch receptors at specific locations along the worm. In particular, muscles in their model contract in response to bending of adjacent posterior segments. For undulations to occur, Niebur and Erdös’ model requires one end of the body (the head in their case) to act as a pacemaker, or self-sustained oscillator. The mechanism for such oscillations is intentionally left unspecified.

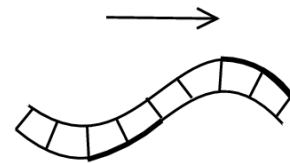

Figure 1: Diagram of the worm broken up into segments. The segments marked in heavy black indicate those that should be contracted [according to (Niebur and Erdös, 1991)] to move the worm in the indicated direction.

Niebur and Erdös based their model on the anatomy of the worm and information from White et al.’s map of the *C. elegans* nervous system (White et al., 1986). The map groups the 302 neurons into 118 classes. The locomotion neurons include ventral motoneurons, dorsal motoneurons and interneurons. The main neurons of interest for forward locomotion are 11 ventral motoneurons (class VB), 7 dorsal motoneurons (class DB) and two interneurons (left and right AVB). Laser-ablation experiments [in which behaviour is recorded before and after identified cells are ablated, (Chalfie et al., 1985)] have demonstrated that these three classes of neurons (VB, DB and AVB) are necessary for forward motion.

The asymmetry in the *C. elegans* circuitry (i.e., the different numbers of ventral and dorsal neurons) is striking. These 7 dorsal and 11 ventral neurons line up along the body and innervate four groups of longitudinally spaced muscles around them (approximately 2×24 dorsal and 2×24 ventral muscles connected to the 7 dorsal and 11 ventral neurons respectively). While the specific neuromuscular connectivity is, to our knowledge, unknown, it appears that motoneurons are generally connected to a number of nearby muscles.

To innervate the muscles in their lateral proximity, the axons of motoneurons of class VB and DB each extend

along the corresponding part of the body. However, from this perspective, these motoneurons have axons that are longer than needed. They extend about one fifth of one body length further than the muscles they are thought to control; nonetheless, it appears that these axon extensions lack synapses, gap junctions or any other obvious function. It was therefore proposed (White et al., 1986) that the ends of these motor neurons contain *stretch receptors* that are sensitive to the posture of the body and are responsible for the feedback needed to generate the observed muscle excitation patterns. Interestingly, these axon extensions protrude in the direction of the tail, indicating that such stretch receptors could facilitate the propagation of a wave of neuronal excitation from the tail forward. Niebur and Erdős incorporate the assumption of stretch receptors into their locomotion model and showed that forward locomotion can be obtained under such conditions (Niebur and Erdős, 1991). (Surprisingly, however, their model assumes a mathematically equivalent formalism wherein oscillations initiate in the head of the worm and propagate backward.) We note that neither White et al. nor Niebur and Erdős give any indication for stretch receptors except at the far ends of these motoneurons.

The suggestion that mechanical feedback to the nervous system largely determines the neuronal activity appears consistent with other information about the neural circuitry. An analysis of the forward locomotion sub-circuit shows that there are only electrical junctions between the main two classes of motoneurons (VB and DB). Furthermore, all VB and DB neurons are electrically coupled to the AVB neurons (which extend along the entire length of the body). This (and simple intuition about interneurons regulating the activity of motoneurons) suggests that perhaps the AVB interneurons function as a switch for forward locomotion. Since the two AVB neurons are electrically coupled and can be assumed to be acting in unison (White et al., 1986), they are approximated as a single unit (denoted here AVB).

3. Methods

A staged approach was chosen due to its ability to break up a complex problem, such as our need to train parameters for a complete circuit, into smaller components. The first stage was to see if it was possible to get one segment to oscillate and then generate a second adjacent segment that oscillates with a lagged phase from the first segment. Finally 11 segments would make a candidate model for the *C. elegans* forward locomotion control system.

3.1 Neuron Model

The graded response of a motoneuron of class VB or DB can be reduced to a simplified equation for the trans-

membrane potential $V(t)$:

$$C \frac{dV}{dt} = -G(V - E) - I^{\text{AVB}} - I^{\text{coupling}} - I^{\text{shape}}, \quad (1)$$

where C is the cell's membrane capacitance; E is the cell's resting potential; G is the total membrane conductance; $I^{\text{AVB}} = G^{\text{AVB}}(V^{\text{AVB}} - V)$ is an input current due to gap junctional coupling with AVB (coupling strength G^{AVB} and AVB voltage V^{AVB}); I^{coupling} is a similar input current due to coupling with other motoneurons, and $I^{\text{shape}} = \sum_{j=1}^n \sigma_j^{\text{stretch}}(\theta_j)$ is the stretch receptor feedback from the shape of the body, where θ_j is the bending angle of segment j and $\sigma_j^{\text{stretch}}$ is a sigmoid response function of the stretch receptors to the local bending. Without loss of generality, we have set the capacitance C to 1 and the resting potential E to 0. Equation 1 assumes that the cell can be represented by a single compartment and that its dynamics can be reduced to a passive response (with a fixed conductance G). In addition, as an *ad hoc* simplification, the term I^{coupling} was omitted (as it was found to be of secondary significance in our model). The sigmoid function is given by

$$\sigma^{\text{stretch}}(\theta) = \frac{A}{1 + \exp(-k(\theta - \theta_0))} \quad (2)$$

where the amplitude A , a steepness parameter k and the threshold θ_0 are constants.

3.2 Neural environment model

We used the simplest possible neural environment to reduce complexity in our simulations, especially where the physiological or anatomical details are not that well understood. The only direct inputs received by the locomotion neural network are through the AVB unit (which is connected to the rest of the nervous system). The sensory information from the head/tail was also ignored as its effect is only maintained through the state of the two neurons of class AVB.

The worm was split up into so-called *segments*: frictionless two-dimensional 'joints' between weightless rods. The bending angle of a segment θ was determined by a summation over contributions of motoneurons innervating the muscles of that segment. Neuromuscular junctions were modelled by sigmoid functions over the neuron's voltage state. The model of segment bending or stretching can be summarised as

$$\frac{d\theta}{dt} = \sum_{i=1}^{N_{\text{VB}}} \sigma_i^{\text{out}}(V) - \sum_{i=1}^{N_{\text{DB}}} \sigma_i^{\text{out}}(V). \quad (3)$$

where $\sigma^{\text{out}}(V) = B/[1 + \exp(-q(V - V_0))]$ with constants B , q and V_0 . This assumes that the muscles are effectively translating the neural output directly into segment stretch. Note that dorsal and ventral muscles contribute to bending in opposite directions.

3.3 Forward locomotion circuit

As a first simplification, the asymmetrical circuitry of the worm was reduced to a symmetrical circuit (with $N_{VB} = N_{DB}$). The circuit chosen for this paper used 11 segments (based on the number of VB neurons). Each segment was assumed to have one ventral neuron ($N_{VB}=1$), one dorsal neuron ($N_{DB}=1$), and one corresponding pair of muscles (VM and DM). The neurons were modelled as described in the above section. Figure 2 summarises this simplified symmetrical circuit.

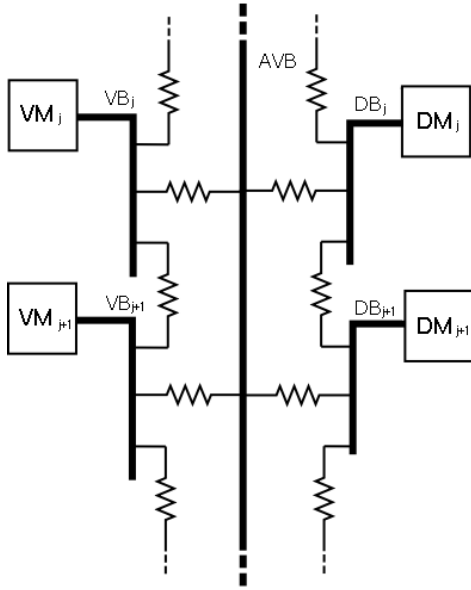

Figure 2: Schematic diagram of the reduced and symmetrized *C. elegans* forward locomotion neural circuitry. Electrical junctions (fast, bi-directional conduits through adjacent cell membranes) are shown as resistors. The electrical junctions between ventral and dorsal neurons (VB and DB, dashed lines) are shown for completeness, but are not actually included in the model. The Neuron somas are located at the anterior end of the neuron (not shown).

3.4 Self-oscillating segment

Our staged approach for building a model of the *C. elegans* locomotion controllers started with a single self-oscillating segment, representing the tail end of the worm. In this model, we have chosen to rely on the existence of stretch receptors, rather than requiring new assumptions about sophisticated neuronal properties. According to our model, the tail segment serves as a conditional pacemaker: It should oscillate whenever the AVB unit is on, and relies on feedback from its own bending angle to generate these oscillations. As mentioned before, the requirement that the oscillator be placed in the tail relies on the specific neuronal morphologies laid out by White et al. (White et al., 1986).

Figure 3 illustrates the single segment model. The

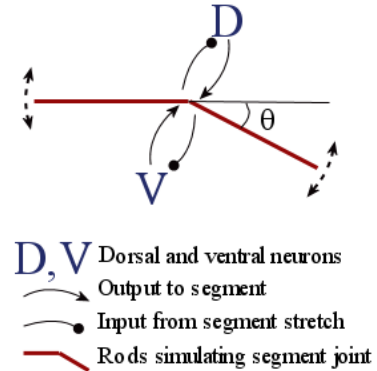

Figure 3: Diagram for the model of a self-oscillating segment.

imposed symmetry of our model distances any circuitry from biological realism, but provides a proof of concept that the neuronal and coupling mechanisms introduced here are sufficient to generate a locomotion-like pattern of activity. We note that despite the symmetry in this circuit, asymmetry is introduced through the neuronal parameters for ventral and dorsal neurons.

Desirable oscillations were identified by simulating the activity of the segment in time and testing for stable periods and stable amplitudes with minimal fluctuations or trends. For instance, the dynamics of an asymmetrical model such as this can include an unwanted downward trend in the segment angle θ .

Numerical analysis of the segment oscillations yielded a numerical value representing the fitness of a solution. The simulation was run three times, (i) with no input from AVB ($I^{AVB}=0$), (ii) with AVB input and (iii) with AVB input and white uniform noise in the segment stretch (θ). (The noise was added stochastically with a probability of 0.05 per time step and an amplitude range of 20% of the desired bending amplitude).

Two fitness functions were introduced: a main fitness function for assessing runs (ii) and (iii) and a control fitness function for run (i). The main fitness function F^{segment} was expressed as a product of various fitness components, as follows:

$$F^{\text{segment}} = f_{\omega} \cdot f_{\text{std}(\omega)} \cdot f_{\theta} \cdot f_{\text{stat}} \cdot f_{\text{damping}} \cdot f_{\epsilon} \quad (4)$$

where f_{ω} rewards any oscillation frequencies below some cut off; $f_{\text{std}(\omega)}$ rewards low relative fluctuations in the undulation frequency; f_{θ} rewards bending angles of a prespecified amplitude; f_{stat} rewards stationary solutions; and finally f_{ϵ} and f_{damping} reward stable and undamped solutions, respectively. The control fitness function for run (i) rewarded low activity. The overall fitness of a solution was obtained by multiplying the fitness values of the three runs.

3.5 Phase-lagged segments

In order to generate a two-segment circuit, with phase-lagged oscillations, the solution obtained for a single self-oscillating segment (above) was used for both segments. One segment continued to serve as a pacemaker (tail segment, right) and the second segment served as a body segment (left). This body segment received mechano-feedback both from the tail and from its own body segment. The inclusion of local feedback is an important extension of the existing hypothesis, according to which feedback from posterior segments is sufficient. The reason for including local feedback will be explained in the Discussion below. Given the two-segment circuitry, it remained to search for fit mechano-feedback parameters connecting the tail and body segments $\sigma^{stretch}$. In addition, the conductance parameters for the body segment neurons G were re-trained.

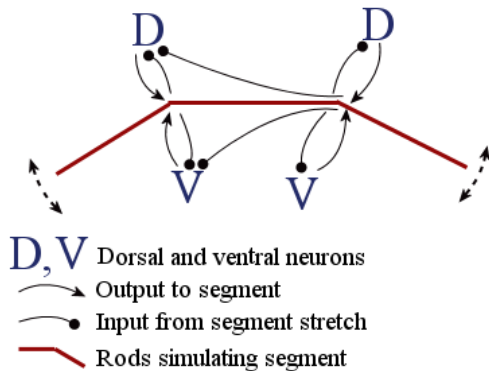

Figure 4: Diagram of the two-segment circuit. The phase-lagged (body) segment on the left should oscillate at a lagged phase relative to the self-oscillating (tail) segment on the right.

The fitness function used to identify desirable phase lags is given by:

$$F^{lag} = F^{segment} \cdot f_{\phi} \cdot f_{\Delta\omega} \quad (5)$$

where f_{ϕ} rewards oscillations at a predetermined phase-lag (see below) and $f_{\Delta\omega}$ rewards minimal discrepancies between the tail and body oscillation frequencies. To determine the optimal phase lag, we used the following argument. Assuming the length of the body includes 11 segments and spans a single wavelength of undulations λ , the phase lag is taken to be of the order of 0.1λ . However, since the neuronal excitation propagates forward from the tail and the physical undulations must propagate backward from the head, the phase lag is reversed to 0.9λ .

3.6 Eleven segment model

The body circuit consisted of a chain of ten phase-lagged (body) segments in sequence in front of a self-oscillating (tail) segment. In order to seek solutions for the entire body circuit, no fitness function was needed. In fact, it was sufficient to run simulations to confirm that the tail oscillations propagate along the body in the desired manner. A graphical tool was used to visualise the behaviour. The visualisation generating parallel copies of the model worm to endow it with a semblance of width.

3.7 Directed search algorithm

To generate fit solutions a directed search algorithm was developed and implemented on a parallel computer.¹ Parameters needed for each stage were generated using a modified random restart hill climber. *Running solutions* were assessed by applying fitness functions to simulation runs under a variety of conditions.

Once a working solution was obtained, mutations were stochastically applied to the solution. Mutated solutions that out perform the running solution would replace it. After 1000 mutations without a replacement, the algorithm would restart with a new random solution. The best solution overall was recorded. Improved search efficiency was obtained by mutating one in five parameters over its complete parameter domain rather than within a 1% boundary.

4. Results

Solutions found by the directed search algorithm are presented in this section, including a self-oscillating segment, a two-segment circuit using the single segment solution, and a full eleven-segment model of the forward locomotion circuit. The solutions obtained are shown to generate stable and robust oscillations. A visual comparison with a video of the biological worm is described. Finally, the consistency of the results with Niebur and Erdős' mechanical model is confirmed.

4.1 Self-oscillating segment

Approximately fifty searches of single self-oscillating segments (Figure 3) were performed (each generating over 300,000 solutions) with different random seeds. The solutions obtained gave rise to a wide variety of undulation waveforms, including square waves, sinusoidal-like waves, triangle waves, pulse waves and saw waves in the segment bending angle θ . Each solution consisted of 16 parameters: G , G^{AVB} , and the three $\sigma^{stretch}$ parameters A , k and θ_0 [equations (1) and (2)] and the three σ^{out} parameters B , q and V_0 [equation (3)].

¹Due to the high number of parameters (16), a systematic search of parameter space (with a simulation-based calculation of fitness for each parameter set) was deemed too lengthy a process.

While many of the solutions demonstrated neuronal oscillations leading to muscle pulse patterns, there was quite a lot of variation in the waveforms, frequencies and oscillation amplitudes. Many solutions consisted of symmetric or nearly symmetric circuits characterised by sinusoidal oscillations in the neurons, with corresponding anti-phase sinusoidal oscillations in the muscles. Other asymmetric solutions consisted of only one active muscle (with the other muscle static). Additional solutions consisted of hybrid circuits with one sinusoidally oscillating muscle and the other generating sharp pulses.

Most of the solutions obtained exhibited regulation by the AVB unit. Thus, neurons and muscles were relatively inactive when the voltage of AVB was set to zero. Further confirmation of this result was obtained in a related circuit model which exhibited frequency modulation by AVB voltage (Bryden, 2003).

Not all single segment solutions found were robust to random noise. Some altered their wavelengths once perturbed; in others the oscillations are lost altogether. Overall, the majority of solutions trained under noisy conditions demonstrated sustained stable activity, thus confirming their tolerance to random perturbation.

Figure 5 shows a particular solution with a square-like waveform. Square-waves constituted relatively rare solutions (only two patterns out of 50). In contrast, the majority of solutions found gave rise to either triangular or saw-shape waveforms.

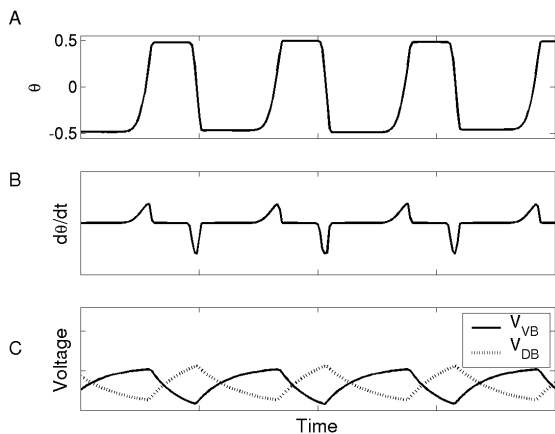

Figure 5: A fit solution of a self-oscillating segment. Graph A shows a trace of oscillations in segment bending angle (θ in radians); graph B shows the input to the muscles DM and VM (equal to $d\theta/dt$); and graph C shows the corresponding voltages of neurons DB and VB in time.

The figure presents time traces of the ‘physical’ bending of the segment (Graph A), the neuronal input to the muscles generating the bending (Graph B), and the underlying neuronal voltage oscillations (Graph C). Since the muscle activity is assumed to translate directly into

bending, the trace of graph B is equivalent to $d\theta/dt$. As shown in the figure, in order to generate the square-like waveform, the input to the muscles should consist of two brief and opposite pulses (Graph B). These, in turn, are generated by anti-phase oscillations in the VB and DB neurons of the segment (Graph C).

Graphs B and C help us better understand the neuronal circuit mechanism. The initial condition is a strongly bent segment ($\theta \approx -0.5$). Consequently, the ventral neuron VB is receiving a positive feedback from the segment, whereas the dorsal neuron DB is receiving negative feedback. Accordingly, trace C begins with a build-up of the VB voltage and a similar but opposite decrease in DB voltage. However, the change in voltage has little effect on the muscles. As the VB voltage approaches its maximal amplitude, a threshold effect begins to activate the corresponding VM muscle. As the muscle bends the segment to the opposite configuration (positive θ), the mechanism is reversed. Now DB is excited and VB inhibited until a threshold in DB is reached and the activation of the dorsal DM muscle completes the cycle. Note that while dorsal and ventral activities are similar, the neuronal and muscle waveforms are not completely symmetric.

4.2 Phase-lagged segments

As described earlier (Figure 4), single segment solutions were combined to make phase-lagged segments. The single-segment solution used for this purpose is the one shown in Figure 5. Henceforth, we restrict our discussion to that solution.

The search algorithm was run fifty times with different seeds, testing around 20,000 solutions. Each solution consisted of 8 parameters: G was retrained, and the three $\sigma_{\text{tail}}^{\text{stretch}}$ parameters A , k and θ_0 were trained [equations (1) and (2)].

One solution is shown in Figure 6. As can be seen in graph A, the body segment oscillates slightly out of phase with the tail segment (appearing to precede it in time). The trace shows an initial transient period of approximately four cycles, during which the body segment gradually phase locks with the tail segment. Naturally, this transient behaviour is not characteristic of the biological worm and reflects the simplicity of the model used here. Furthermore, the directed search was not designed to penalise transient phases.

Graph B of the same figure illustrates how the output from the neurons is also phase-lagged, with the body-segment neurons displaying a similar pattern to the tail neurons. A comparison of this excitation pattern with that identified by Niebur and Erdős in (Niebur and Erdős, 1991) demonstrates that the two are qualitatively similar. The neurons only innervate muscles just before the segment bending is about to switch from one extremum to the other, i.e., when the segment

lies on the outer curve of the ‘S’ shape of the *C. elegans* body, toward the direction of the locomotion (as shown in Figure 1).

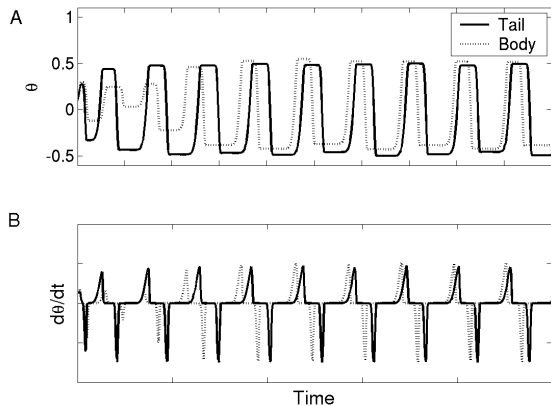

Figure 6: Two phase-lagged segments. Graph A shows the segment oscillations (θ is in radians); graph B shows the input to the segments from their muscles DM and VM (equal to $d\theta/dt$). The two segments oscillate approximately 9/10 of a cycle out of phase. An initial transient phase can be observed until the oscillations settle at a stable frequency and amplitude.

All fifty results from the search algorithm showed the same neural activity patterns. The only observed differences were in the amplitude ranges of the phase-lagged segment, the phase-lag and the durations of the transient phases at the starts of the oscillations. All solutions were characterised by a brief initial transient phase. The details of the transient phase depended on the initial condition of the simulation. We note that the steady-state periods of oscillation, amplitudes and phase-lags are independent of initial conditions.

4.3 Random perturbations

The addition of random perturbations demonstrated the robustness of the oscillation mechanism. Figure 7 presents a typical simulation result in which both segments were subjected to random perturbations. Note that the transient phase appears to be shorter, however this was just an artefact of that particular run. In general, perturbations did not significantly affect the duration of the initial transients.

4.4 Eleven phase lagged segments

To build up a complete model of the forward locomotion circuitry, ten phase-lag body segments (as shown in the previous section) were linked together in front of a self-oscillating tail segment. Figure 8 shows a sequence of four still frames from a simulation of an 11-segment cir-

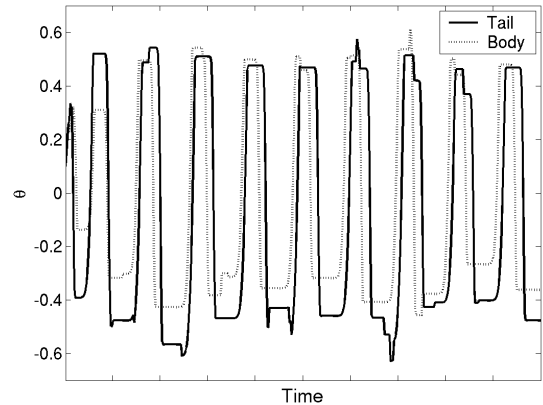

Figure 7: Two phase-lagged segments subjected to random perturbations. The segment bending angles θ are in radians.

cuit, juxtaposed with four frames of the biological worm. In each image, dots were placed alongside those segments of the simulation model whose muscles are active during that time frame. The biological worm moves on its side with the ventral and dorsal muscles generating lateral undulations. The simulated worm is also on its side with lateral undulations generated by the ventral and dorsal muscles.

The dots beside the worm are adjacent to segments where the neurons are excited enough to activate the muscles and move the segment. As can be seen they are in similar positions to the heavy black lines in Figure 1. This implies that the results found are consistent with the mechanical model developed by Niebur and Erdős (Niebur and Erdős, 1991). Videos of both the biological and the simulated worm moving can be viewed at <http://www.comp.leeds.ac.uk/johnb/celegans>.

5. Discussion

This paper presents a toy model of the forward locomotion controllers for *C. elegans*. The model uses mechano-feedback to generate oscillations at the tail and to propagate them along the body. We have shown that this mechanism can be used to generate undulations that propagate backward along the body thus sustaining forward locomotion in a simple simulation model. The model raises questions about the validity of typical motor control paradigms for the *C. elegans* circuit. In particular, the reliance on mechano-feedback in our circuit raises doubts about the applicability (to *C. elegans* motor control) of the often taken approach that the environment plays only a minor role in pattern generation.

The model incorporates knowledge about the neurobiology of the worm. Where experimental evidence is lacking, we followed biologically reasonable assumptions [in line with (Ferré and Lockery, 1999,

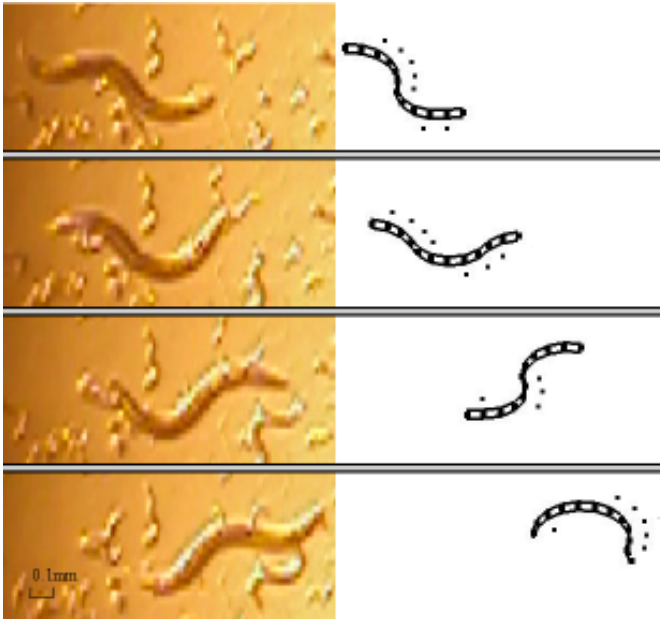

Figure 8: Comparison of biological worm with simulated worm. Left side shows four stills of an adult hermaphrodite *C. elegans* moving horizontally across agar, the worm is moving from left to right. Right side shows four stills from the output of the viewer application – the lateral movement of the worm has been introduced manually to make it easier to compare with the biological worm. Dots have been placed outside the worm adjacent to segments where $d\theta/dt$ is non-zero. Scales are approximate. Digital video was taken at Ian Hope’s Laboratory, School of Biology, University of Leeds, LS2 9JT.

Ferrée and Lockery, 1998, Goodman et al., 1998, Niebur and Erdös, 1993, Niebur and Erdös, 1991)]. First, the neuronal activity was that of graded potential neurons. The models of the neurons were consistent with those identified by (Ferrée and Lockery, 1999, Ferrée and Lockery, 1998). The model also followed the general understanding that locomotion control circuitry was effectively isolated from the rest of the nervous system (White et al., 1986). In all these respects, the models generated are hoped to be biologically realistic.

In other respects, our model diverged from biological realism. Most importantly, the decision to partition the worm and its nervous system into structural segments was followed purely for convenience. In contrast, the biological worm has 11 ventral neurons and 7 dorsal neurons in its locomotion circuitry (White et al., 1986). There is no common factor which allows for such a circuit to be broken down into segments.

Secondly, the physical model for the worm was a simplistic one. This simple model demonstrates a neuronal mechanism through which waves of undulations are generated in a simulated worm. In the presence of friction,

such undulations would have generated forward motion. However, this work stops short of building a mechanical model of the worm and its interactions with a physical environment.

The parsimony of our model has nevertheless allowed us to focus on the neural dynamics, without concern for the added complexity of mechanical effects. This approach enabled us to produce a detailed neuronal model of locomotion control as compared with (Niebur and Erdös, 1991). The results of the model were consistent with Niebur and Erdös’ mechanical model. In particular the patterns of muscle activation generated by our model appear qualitatively similar to those found by Niebur and Erdös. Interestingly the search algorithm did find various other candidate patterns of muscle activation. An evaluation and comparison of these may prove fruitful.

The model chosen by Niebur and Erdös relied on stretch receptor feedback to generate propagation of undulations. This was our starting point as well. However, the neurons in Niebur and Erdös’ model only have stretch receptors on the tips of the neurons, and therefore do not receive local feedback. Our simulations of such circuits all led to unstable solutions that are highly sensitive to perturbations (data not shown). Hence, the neurons in our model receive feedback from the local segment as well as feedback from the adjacent posterior segment. This indeed led to stable solutions that were robust to random perturbations both in the body and in the tail. Thus, one natural and testable prediction of our model is that the stretch receptors are located over the full length of the neuron bodies rather than at the tips alone.

Of course, it is possible that the mechanical dynamics of the biological worm are different to those demonstrated by the minimal environment chosen for our model. We hope that the consistency evident between our model and the mechanical model produced by Niebur and Erdös implies that mechanical effects extraneous to our model are compatible with it. If so, the addition of mechanical realism to the physical environment of our model might enable us to demonstrate the validity of our model further. Such extensions could shed light on the function of neurons and neural connections not explained by our model.

Proposed extensions to the model therefore include such additions of biological realism such as friction and elasticity. A performance-based fitness factor that takes account of how fast the worm was capable of moving would also be an interesting approach. An approach that used one stage, i.e., all parameters trained at the same time, may lead to fresh insights.

The simulation modelling techniques presented in this paper have enabled us to generate a feasible simplified model of the *C. elegans* forward locomotion controllers.

The approach of splitting the problem up into manageable smaller constituents proved successful in generating a solution that appears promising, both in terms of its biological realism and in terms of its functionality and robustness to noise. The application of a directed search algorithm led to satisfactory solutions at each stage of development. While a variety of solutions were found, in this paper we focused on one particular solution that appeared consistent with complementary models in the literature. The results in this paper reiterate the potential value in using a combined search/simulation modelling approach to the design (and indeed reverse engineering) of neural circuits for motor control in simple biological and bio-inspired systems.

6. Acknowledgements

Ian Hope has been very accommodating in allowing us access to *C. elegans* worms in his laboratory and has provided numerous suggestions. Special thanks to Jason Noble for many useful discussions and critical comments. David Gordon helped with the graphical software for visualisation of the simulation results.

References

- Bryden, J. (2003). A simulation model of the locomotion controllers for the nematode *Caenorhabditis elegans*. Master's thesis, University of Leeds.
- Chalfie, M., Sulston, J., White, J., Southgate, E., Thomson, J., and Brenner, S. (1985). The neural circuit for touch sensitivity in *Caenorhabditis elegans*. *Journal of Neuroscience*, 5(4):956–964.
- Chalfie, M. and White, J. (1988). The nervous system. In Wood, W., (Ed.), *The Nematode Caenorhabditis elegans*. Cold Spring Harbor Laboratory, Cold Spring Harbor, NY.
- Ferrée, T. C. (2003). Motivations for nemasys. <http://www.csi.uoregon.edu/projects/celegans/nemasys/Motivation.htm>.
- Ferrée, T. C. and Lockery, S. R. (1998). Chemotaxis control by linear recurrent networks. *Journal of Computational Neuroscience: Trends in Research*, pages 373–377.
- Ferrée, T. C. and Lockery, S. R. (1999). Computational rules for chemotaxis in the nematode *C. elegans*. *Journal of Computational Neuroscience*, 6:263–277.
- Goodman, M., Hall, D., Avery, L., and Lockery, S. (1998). Active currents regulate sensitivity and dynamic range in *C. elegans* neurons. *Neuron*, 20:763–772.
- Gray, L. (1950). The kinetics of locomotion of the grass snake. *Journal of Experimental Biology*, 26:354.
- Gray, L. (1953). Undulatory propulsion. *Quarterly Journal of Microscopical Science*, 94:551.
- Ijspeert, A. (2001). A connectionist central pattern generator for the aquatic and terrestrial gaits of a simulated salamander. *Biological Cybernetics*, 84(5):331–348.
- Ijspeert, A., Hallam, J., and Willshaw, D. (1999). Evolving swimming controllers for a simulated lamprey with inspiration from neurobiology. *Adaptive Behavior*, 7(2):151–172.
- Marder, E. and Calabrese, R. (1996). Principles of rhythmic motor pattern generation. *Physiological Reviews*, 76(3):687–717.
- Niebur, E. and Erdős, P. (1991). Theory of the locomotion of nematodes. *Biophysical Journal*, 60:1132–1146.
- Niebur, E. and Erdős, P. (1993). Modeling locomotion and its neural control in nematodes. *Comments on Theoretical Biology*, 3(2):109–139.
- Rose, J. K. and Rankin, C. (2001). Analyses of habituation in *C. elegans*. *Learning and Memory*, 8:63–69.
- The *C. elegans* Sequencing Consortium (1998). Genome sequence of the nematode *caenorhabditis elegans*. a platform for investigating biology. *Science*, 282:2012–2018.
- White, J., Southgate, E., Thomson, J., and Brenner, S. (1986). The structure of the nervous system of the nematode *C. elegans* (the mind of a worm). *Philosophical Transactions of the Royal Society London. Series B, Biological Sciences*, 314(1165):1–34.
- Wicks, S., Roehrig, C., and Rankin, C. (1996). A dynamic network simulation of the nematode tap withdrawal circuit: Predictions concerning synaptic function using behavioral criteria. *Journal of Neuroscience*, 16:4017–4031.
- Wood, W. (1988). Introduction to *C. elegans* biology. In Wood, W., (Ed.), *The Nematode Caenorhabditis elegans*. Cold Spring Harbor Laboratory, Cold Spring Harbor, NY.